

Area and Perimeter Warm Up Questions

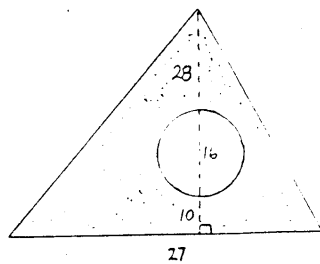

- 18.0
- 113
- 4.8
- 39.1

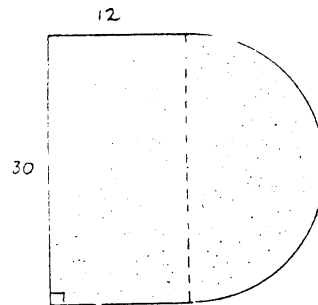
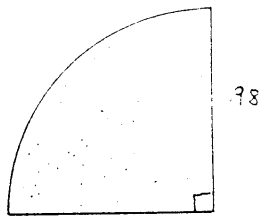
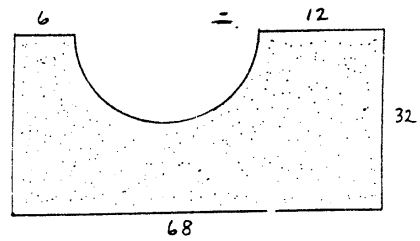
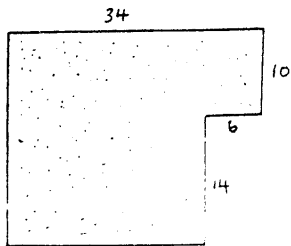
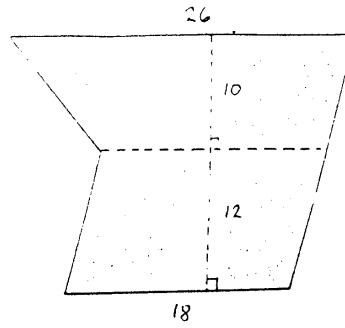
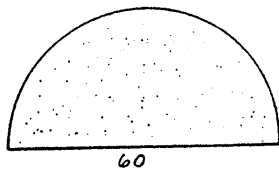
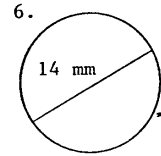
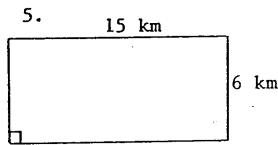
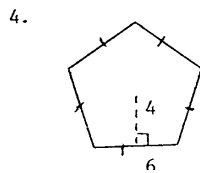
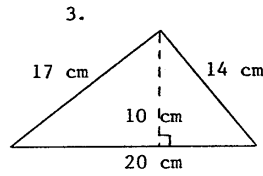
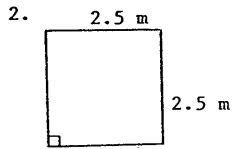
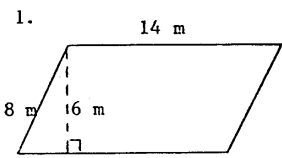
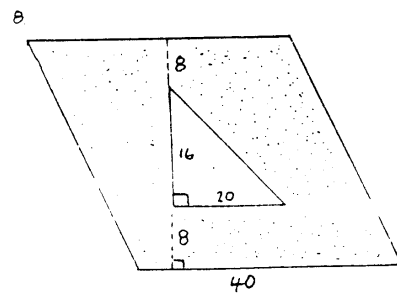

To make these questions easier, draw a picture and label with the measurements before proceeding.

Calculate the length of weather stripping necessary to fit around the edge of a door whose measurements are 80 cm by 200 cm.

A rec-room measuring 8.2 m by 4.3 m has its floor partly covered by a rug so that a border of 50 cm is left between the wall and the edge of the rug on all sides. Find the perimeter of the rug.

During the building of a garage, a diagonal brace is used to temporarily stabilize a sidewall that measures 8 m by 2.5m. Determine the length of the brace, to the nearest tenth.

A communications satellite has a circular orbit about the earth and travels 42 200 km in each orbit. If the radius of the earth is approximately 6370 km, how far is the satellite above the earth's surface?

A horse is tied to a tree by a rope 16 m long.

- What area is available to it for grazing?
- How far does it travel if it trots once around the tree with the rope taut?

It is planned to cover a field that is in the shape of a rectangle with semicircular ends, with artificial turf costing \$27.00/m². What would be the total cost?

